

VPAM

Vereinigung der
Prüfstellen für angriffs-
hemmende Materialien
und Konstruktionen

Protective equipment
Bullet-resistant helmet, visor and neck guard
- Requirements, classifications and test
procedures -

VPAM
HVN 2009
Status: 04.04.2017

TEST GUIDELINE

Bullet-resistant helmet with visor and neck guard"

Publisher:

Association of Test Centres for attack-resistant
materials and constructions (VPAM)

Englische Übersetzung, es gilt immer die deutsche Originalfassung!

English translation, however the original German version always prevails!

Status: 04.04.2017

	<p align="center">Protective equipment Bullet-resistant helmet, visor and neck guard - Requirements, classifications and test procedures -</p>	<p align="center">VPAM HVN 2009 Status: 04.04.2017</p>
---	---	--

First edition of VPAM HVN 2009: 06.11.2009

Proof of amendment

Amendment		Amendments are made under the following figures
No.	Date	
1	12.05.2010	No. 6.6.1, 6.11.1 and Appendix 4
2	05.02.2014	Appendix 9 supplier Seifenkopf
3	04.04.2017	Status change, new status 04.04.2017 Appendix 9 supplier Seifenkopf <i>Footnote deleted, supplier is determined internally by the VPAM members</i>

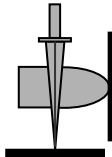
 <p>VPAM Vereinigung der Prüfstellen für angriffs- hemmende Materialien und Konstruktionen</p>	<p>Protective equipment Bullet-resistant helmet, visor and neck guard - Requirements, classifications and test procedures -</p>	<p>VPAM HVN 2009 Status: 04.04.2017</p>
--	---	---

Foreword

This guideline was drafted by the Association of Test Centres for attack-resistant materials and constructions (VPAM).

Supplier of VPAM - HVN 2009:



Agency

**Deutsche Hochschule der Polizei
(German Police College)**

**Polizeitechnisches Institut
(Technical Institute of Police)**

Postfach 48 03 53

48080 Münster

Germany

Tel.: +49 (0) 25 01 806-259

Fax: +49 (0) 25 01 806-239

E-Mail: pti@dhpol.de

Internet: www.vpam.eu or www.dhpol.de

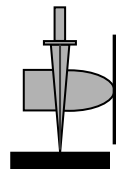

VPAM

Vereinigung der
Prüfstellen für angriffs-
hemmende Materialien
und Konstruktionen

Protective equipment
Bullet-resistant helmet, visor and neck guard
- Requirements, classifications and test
procedures -

VPAM
HVN 2009
Status: 04.04.2017

Contents

INTRODUCTION	6
1 AREA OF APPLICATION	7
2 NORMATIVE REFERENCES	8
3 TERMS	9
3.1 BULLET-RESISTANT HELMET	9
3.2 BULLET-RESISTANT VISOR	9
3.3 BULLET-RESISTANT NECK GUARD	9
3.4 TEST SAMPLES	9
3.5 SAMPLES	9
3.6 ANCHORAGE POINT	10
3.7 BULGING/DEFORMATION	10
3.8 BULGING/DEFORMATION INDICATOR	10
3.9 MEASURING HEAD FOR THE DETERMINATION OF RESIDUAL ENERGY	10
4 REQUIREMENTS, CLASSIFICATIONS AND TEST CONDITIONS	11
4.1 GENERAL REQUIREMENTS, CLASSIFICATIONS AND TEST CONDITIONS	11
4.2 PERMISSIBLE BULGING/DEFORMATION	11
4.2.1 Helmet	11
4.2.2 Visor	11
4.2.3 Neck guard	11
4.3 PERMISSIBLE ENERGY TRANSFERRED TO THE HEAD	11
5 TEST EQUIPMENT AND TEST INSTRUMENTS	12
5.1 MEASURING AND TARGET CONSTRUCTION	12
5.2 BULLET/SPLINTERING INDICATOR	12
5.2.1 Helmet	12
5.2.2 Visor	12
5.3 BULGING/DEFORMATION INDICATOR	12
5.4 INDICATOR FOR RESIDUAL ENERGY MEASUREMENT	13
6 TEST PROCEDURE	14
6.1 NUMBER OF TEST SAMPLES	14
6.1.1 Helmet	14
6.1.2 Visor	14
6.1.3 Neck guard	14
6.2 SIZE OF THE TEST SAMPLES	14
6.3 CONDITIONING OF THE TEST SAMPLES	14
6.4 AFFIXING OF THE TEST SAMPLES	15
6.4.1 Helmet	15
6.4.2 Visor	15

	Protective equipment Bullet-resistant helmet, visor and neck guard - Requirements, classifications and test procedures -	VPAM HVN 2009 Status: 04.04.2017
---	---	--

6.4.3	Neck guard	15
6.5	DETERMINATION OF THE IMPACT POINTS	15
6.6	NUMBER AND DISTANCE OF THE STRIKES	15
6.6.1	Helmet	15
6.6.2	Visor	16
6.6.3	Neck guard	16
6.7	IMPACT ANGLE	16
6.8	TESTING OF THE ANCHORAGE POINTS	16
6.9	INSTALLATION OF THE BULGING/DEFORMATION INDICATOR	16
6.10	INSTALLATION OF THE SHOT/SPLINTER INDICATOR	16
6.11	PERFORMANCE OF THE TESTS	17
6.11.1	Helmet	17
6.11.2	Visor	17
6.11.3	Neck guard	17
6.12	ASCERTAINMENT OF THE TEST RESULTS	17
7	EVALUATION AND DOCUMENTATION OF THE TEST, TEST CERTIFICATE	19
	APPENDIX 1: MEASURING AND TARGET CONSTRUCTION (DIAGRAMMATIC)	20
	APPENDIX 2: HELMET ATTACHMENT (DIAGRAMMATIC)	21
	APPENDIX 3: ATTACHMENT OF THE BULGING/DEFORMATION INDICATOR FOR TESTING OF THE VISOR (DIAGRAMMATIC)	22
	APPENDIX 4: ATTACHMENT OF THE BULLET/SPLINTERING INDICATOR (DIAGRAMMATIC)	22
	APPENDIX 4: ATTACHMENT OF THE BULLET/SPLINTERING INDICATOR (DIAGRAMMATIC)	23
	APPENDIX 5: DETERMINATION OF THE IMPACT POINTS ON THE VISOR (DIAGRAMMATIC)	25
	APPENDIX 6: DETERMINATION OF THE IMPACT POINTS ON THE HELMET (DIAGRAMMATIC)	26
	APPENDIX 7: DETERMINATION OF THE IMPACT POINTS ON THE NECK GUARD (DIAGRAMMATIC) ..	27
	APPENDIX 8: IMPACT ANGLE IN ACC. WITH NO. 6.7 (DIAGRAMMATIC)	28
	APPENDIX 9: MEASURING HEAD FOR ASCERTAINMENT OF THE RESIDUAL ENERGY	29

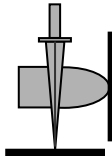
 <p>VPAM Vereinigung der Prüfstellen für angriffs- hemmende Materialien und Konstruktionen</p>	<p>Protective equipment Bullet-resistant helmet, visor and neck guard - Requirements, classifications and test procedures -</p>	<p>VPAM HVN 2009 Status: 04.04.2017</p>
--	---	---

Introduction

The bases for ballistic tests and/or conformity evaluations¹ of materials, constructions and products which offer protection from attacks with firearms are described in the 'General Test Bases for Ballistic Material, Construction and Product Tests', VPAM - APR 2006.

This test guideline additionally describes the product-specific requirements, classifications and test procedures for a 'Bullet-resistant helmet with a visor and neck guard' (HVN).

¹The term 'tests' is used hereinafter for simplification of the text.

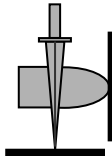
 VPAM Vereinigung der Prüfstellen für angriffs- hemmende Materialien und Konstruktionen	Protective equipment Bullet-resistant helmet, visor and neck guard - Requirements, classifications and test procedures -	VPAM HVN 2009 Status: 04.04.2017
---	---	--

1 Area of application

This test guideline describes requirements, classifications and test procedures for bullet-resistant

- **Helmets**
- **Visors**
- **Neck guards.**

This guarantees reproducible results on the one hand and provides the customer and user with greater market transparency on the other hand as he can objectively compare products from different providers tested in accordance with this guideline.

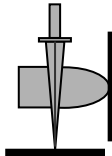
 <p>VPAM Vereinigung der Prüfstellen für angriffs- hemmende Materialien und Konstruktionen</p>	<p>Protective equipment Bullet-resistant helmet, visor and neck guard - Requirements, classifications and test procedures -</p>	<p>VPAM HVN 2009 Status: 04.04.2017</p>
--	---	---

2 Normative references

The following normative documents contain determinations which are part of this guideline by reference in this text. Dated references do not record subsequent amendments or revisions of these publications.

However, contractual partners using this guideline are recommended to check the possibility of using the most recent editions in each instance of the subsequently specified normative documents.

For undated references, the latest edition of the normative document referred to must be used. The respectively applicable version of legal provisions must always be used.

- **VPAM - APR 2006**, General test bases for ballistic material, construction and product tests
- **VPAM - KDIW 2004**, 'Stab and impact protection' test guideline
- **ECE R 22**, Uniform conditions for the approval of protective helmets and their visors for drivers and passengers of motorcycles and mopeds

	<p style="text-align: center;">Protective equipment Bullet-resistant helmet, visor and neck guard - Requirements, classifications and test procedures -</p>	<p style="text-align: center;">VPAM HVN 2009 Status: 04.04.2017</p>
---	--	---

3 Terms

The following terms apply to the use of this test guideline:

3.1 Bullet-resistant helmet (hereinafter referred to as 'helmet')

Generally a product made from one or multiple layers of fabric, plastic or metal. The individual layers can be joined by gluing, welding, soldering, weaving, screwing or clamping. The interior construction can, for example, be executed as a hard foam inner shell or as a belt strap-on device.

3.2 Bullet-resistant visor (hereinafter referred to as 'visor')

Generally a product made from one or multiple layers of glass and/or plastic. The individual layers can be joined together by gluing, screwing or clamping, for example.

3.3 Bullet-resistant neck guard (hereinafter referred to as 'neck guard')

Generally a product made from one or multiple layers of fabric, plastic or metal. The individual layers can be joined together by gluing, welding, soldering, weaving, screwing or clamping for example.

3.4 Test samples

- For helmet test: A helmet with a complete set of internal equipment
- For visor test: A visor affixed to the relevant helmet.
- For neck guard test: A neck guard which is affixed to the relevant helmet.

3.5 Sample

Several test samples necessary for testing in accordance with this test guideline.

	<p style="text-align: center;">Protective equipment Bullet-resistant helmet, visor and neck guard - Requirements, classifications and test procedures -</p>	<p style="text-align: center;">VPAM HVN 2009 Status: 04.04.2017</p>
---	---	---

3.6 Anchorage point

Sites on the helmet at which this is predominantly connected with other devices permanently (internal equipment) or temporarily, if necessary with additional devices such as visor, neck/ear protection or auditory/speech headset.

3.7 Bulging/deformation

Residual or non-residual (dynamic) bulging/deformation on the interior (reverse) of the test sample as a consequence of the shot.

3.8 Bulging/deformation indicator

A device with Plasticine which indicates bulging/deformation (see Appendix 3).

3.9 Measuring head for the determination of residual energy

A soap device which facilitates determination of residual energy for bulging/deformation (see Appendix 9).

	<p style="text-align: center;">Protective equipment Bullet-resistant helmet, visor and neck guard - Requirements, classifications and test procedures -</p>	<p style="text-align: center;">VPAM HVN 2009 Status: 04.04.2017</p>
---	--	---

4 Requirements, classifications and test conditions

4.1 General requirements, classifications and test conditions

Bullet-resistant helmets, visors and neck guards are divided into classes in accordance with the test stages of VPAM - APR 2006, No. 4.1, Table 1.

Insofar as stab and impact protection requirements exist, tests must be conducted in accordance with the VPAM - KDIW 2004 testing guideline.

4.2 Permissible bulging/deformation

4.2.1 Helmet

The arising residual or dynamic bulging/deformation when a helmet is shot at must be kept as small as possible. Evaluation is performed in accordance with No. 4.3.

4.2.2 Visor

The bulging/deformation of the visor may not be greater than 30 mm when shooting.

4.2.3 Neck guard

The neck guard must be sufficiently stable for a striking shot not to be deflected laterally or downwards.

4.3 Permissible energy transferred to the head

The energy transferred to the head upon shooting may not be more than 25 joules for all helmet sizes. The test is conducted with a measuring head in accordance with (Appendix 9).

	<p style="text-align: center;">Protective equipment Bullet-resistant helmet, visor and neck guard - Requirements, classifications and test procedures -</p>	<p style="text-align: center;">VPAM HVN 2009 Status: 04.04.2017</p>
---	--	---

5 Test equipment and test instruments

The test and measuring instruments and the test procedures are determined in VPAM - APR 2006, Nos. 5 and 6.

It must be ensured that the parameters determined in VPAM - APR 2006 under No. 4.1, Table 1 are fulfilled.

5.1 Measuring and target construction

The measuring and target construction must conform to Appendix 1 of this guideline.

5.2 Bullet/fragment indicator

5.2.1 Helmet

In order to ascertain a bullet, a bullet indicator in accordance with VPAM – APR 2006, No. 5.5, must be used which must be positioned in the helmet at a suitable distance from the rearward impact point of the bullet (description of the device, see Appendix 4).

5.2.2 Visor

A fragment indicator in accordance with VPAM - APR 2006, No. 5.4 must be used to determine the splintering behind the visor at a suitable distance from the rearward impact point of the bullet (description of the device, see Appendix 4).

5.3 Bulging/deformation indicator

To determine the bulging depth/deformation of the visor an indicator must be used (description of the device, see Appendix 3).

The Plasticine² must be inserted into a box with internal dimensions of 350 mm x 400 mm x 150 mm for the plasticity measurement. This must be completely filled to the edges and air pockets must be avoided. The box must be placed in storage for at least 16 hours before the test at a constant temperature (± 2 °C) which guarantees the plasticity of 20.0 ± 2.0 mm. Before the plasticity measurement, the Plasticine must be processed with approx. 30 blows (e.g. wooden mallet) and the Plasticine then removed.

² Supplier: Plasticine from. Carl Weible KG, Postfach 1648, 73606 Schorndorf, Germany

	Protective equipment Bullet-resistant helmet, visor and neck guard - Requirements, classifications and test procedures -	VPAM HVN 2009 Status: 04.04.2017
---	---	---

The box with the Plasticine must be placed on a sufficiently firm base area. A drop-testing mechanism with a steel ball (diameter 63.5 ± 0.05 mm, mass 1039 ± 5 g) must be used to test the plasticity of the Plasticine. The distance between the underside of the ball and the surface of the Plasticine must be 2000 ± 5 mm. The even surface or the tangential level to the surface of the Plasticine must be horizontal at the impact point of the ball with an accuracy of ± 5 mm at 1 m. The ball must fall onto the Plasticine five times. The centre of the impact point must be at a distance of approx. 80 mm from any edge of the box and approx. 140 mm from the centre of another impact point. The impressions (troughs) in the Plasticine result in a 'pentagonal dice'. Before or after each fall of the ball, the Plasticine must be removed and the impression depth subsequently measured. The resulting troughs must not be filled up. The deepest point of the ball impression in the Plasticine, in relation to the surface of the Plasticine before the test must be measured with a measurement accuracy of ± 0.5 mm.

The Plasticine is acceptable at the used pre-treatment temperature, if the depth of each trough is 20.0 ± 2.0 mm.

The Plasticine must fulfil the impression geometry requirement during the test duration. The plasticity must be measured for verification before the testing of a sample and the average value must be calculated from the five measurements which must then be recorded in the test report.

The Plasticine for the bulging indicator must be taken from the box. During the test it must be ensured that the plasticity of the Plasticine remains within tolerances.

5.4 Indicator for residual energy measurement

A measuring head made of ballistic soap (Appendix 9) must be used to determine the residual energy transferred to the head in the event of non-impact of a helmet.

The transferred energy is determined by measuring the volume V_p of the dent formed in the measuring head by the helmet bulging.

With the volume V_e generated by the ball during the falling test the transferred energy E_p results as:

$$E_p = 20,4 \cdot \frac{V_p}{V_e} \quad [\text{J}]$$

The calibration of the volume-energy ratio must be undertaken on the same measuring head using the test device for verification of the plasticity of the Plasticine (Ball **0** 63.5 ± 0.05 mm, mass 1039 ± 5 g, falling height 2000 ± 5 mm). The measuring head must be dissected in accordance with Appendix 9 after the test, the ball dropped once onto the intersection of the lower head area and the volume V_e ascertained.

	<p style="text-align: center;">Protective equipment Bullet-resistant helmet, visor and neck guard - Requirements, classifications and test procedures -</p>	<p style="text-align: center;">VPAM HVN 2009 Status: 04.04.2017</p>
---	--	---

6 Test procedure

6.1 Number of test samples

6.1.1 *Helmet*

Seven identical test samples (sample) must be submitted at the same time for each helmet to be examined. The seventh helmet is intended as a reserve.

- 3 helmets with complete internal equipment for testing of bullet resistance in accordance with No. 4.1 and No. 6.3
- 1 helmet with complete internal equipment for testing of the anchorage points
- 2 helmets with complete internal equipment for determination of the residual energy in accordance with No. 4.3

6.1.2 *Visor*

Seven identical test samples together with a helmet must be submitted at the same time for each visor to be examined (the visor can only be examined in conjunction with the relevant helmet). The seventh visor is intended as a reserve.

6.1.3 *Neck guard*

Seven identical test samples together with a helmet must be submitted at the same time for each of the neck guards to be examined (neck guard can only be examined in conjunction with the relevant helmet). The seventh neck guard is intended as a reserve.

6.2 Size of the test samples

Helmets in ready-to-wear size 62 are necessary for the test.

6.3 Conditioning of the test samples

The test samples must be conditioned in equal parts for at least 16 hours before the test at

- -20 ± 2 °C
- $+20 \pm 2$ °C and 65 ± 5 % rel. air humidity
- $+70 \pm 2$ °C

	Protective equipment Bullet-resistant helmet, visor and neck guard - Requirements, classifications and test procedures -	VPAM HVN 2009 Status: 04.04.2017
---	---	--

6.4 Affixing of the test samples

6.4.1 Helmet

For testing in accordance with No. 4.1 the helmet must be affixed by means of a rigid mechanism in such a way that it cannot detach itself from the retaining device (see Appendix 2) as a result of the shot.

For testing in accordance with No. 4.3 the helmet must be placed on a measuring head (see Appendix 9) in accordance with the manufacturer's wearing instructions and the chin strap buckled up. The helmet with measuring head must then be affixed in accordance with Appendix 2. During the test it must be ensured that the helmet is placed in a position in which the entire mass of the measuring head does not have an impact on the chin strap.

6.4.2 Visor

The visor can only be tested in conjunction with the helmet. The helmet must be fixed together with the visor in accordance with No. 6.4.1.

6.4.3 Neck guard

The neck guard can only be tested in conjunction with the helmet. The helmet must be fixed together with the neck guard in accordance with No. 6.4.1.

6.5 Determination of the impact points

On the test sample, the impact points must be identified and numbered in accordance with Appendices 5, 6 and 7 of this guideline.

6.6 Number and distance of the strikes

6.6.1 Helmet

For the test in accordance with No. 4.1 5 strikes must be positioned on a helmet in accordance with Appendix 6. The strikes must be distributed uniformly on the surface. A further strike must be positioned in a random place, 20 + 5 mm from the edge and at least 80 mm from a strike which has already occurred.

For testing in accordance with No. 4.3 2 strikes in each instance must be positioned at random on two helmets with complete internal equipment in accordance with Appendix 6 for determination of the residual energy.

	<p style="text-align: center;">Protective equipment Bullet-resistant helmet, visor and neck guard - Requirements, classifications and test procedures -</p>	<p style="text-align: center;">VPAM HVN 2009 Status: 04.04.2017</p>
---	---	---

6.6.2 Visor

Two strikes must be positioned on a visor in such a way (Appendix 5) that their distance from one another is at least 100 mm and from the visor edge at least 50 mm. On the visor conditioned at $+ 20 \pm 2$ °C the bulging/deformation must be measured at the first strike (Appendix 3).

A strike at a distance of $20 + 5$ mm from the lower or lateral edge must be positioned on a further visor. The second strike must be positioned in the transitional area between the visor clamp and the panel or in the overlap area between the helmet and the visor (Appendix 5). The exact position must be determined by the testing institute.

6.6.3 Neck guard

On a neck guard 2 strikes must be positioned (Appendix 7) in such a way that their distance from one another is at least 80 mm and from the edge at least 50 mm (does not apply to the overlap area).

Two shots must be positioned on a further neck guard in the transitional area to the helmet shell in such a way that their distance from one another is at least 80 mm. The exact position must be determined by the testing institute.

6.7 Impact angle

The shot must strike at an angle of $90^\circ \pm 2^\circ$ ($0^\circ \pm 2^\circ$ NATO) (vertical impact angle = horizontal and vertical tangent of the impact point on the spherical ball), see Appendix 8.

6.8 Testing of the anchorage points

The helmet must be tested with the complete equipment (tempered at $+ 20 \pm 2$ °C). A shot must be emitted in each instance at each anchorage point at an angle of $90^\circ \pm 2^\circ$ ($0^\circ \pm 2^\circ$ NATO).

6.9 Installation of the bulging/deformation indicator

The bulging/deformation indicator (structure, see Appendix 3) must be configured in such a way that bulgings/deformations can be displayed.

6.10 Installation of the shot/splinter indicator

The indicator must be installed in accordance with Appendix 4.

	<p style="text-align: center;">Protective equipment Bullet-resistant helmet, visor and neck guard - Requirements, classifications and test procedures -</p>	<p style="text-align: center;">VPAM HVN 2009 Status: 04.04.2017</p>
---	---	---

6.11 Performance of the tests

6.11.1 *Helmet*

Helmets conditioned in accordance with No. 6.3 must be tested for bullet resistance in accordance with No. 4.1. Removable interior equipment must be removed before conditioning and their anchorage elements replaced. The helmet attachment must be performed in accordance with Appendix 2. In this regard, no ascertainment of bulging/deformation is necessary.

Tempered and cooled test samples must be fired three minutes in each instance after removal from the temperature conditioning. All further shots must be emitted at three-minute intervals.

To verify the anchorage points a helmet with complete internal equipment must be used at $+ 20 \pm 2$ °C.

The residual energy in accordance with No. 4.3 must be determined on two helmets with complete internal equipment. The helmets must be tempered at $+ 20 \pm 2$ °C before the test.

If a weak point is detected within the scope of a test which is not detected with the tests of this guideline, it is at the discretion of the testing laboratory as to whether further tests are performed on the basis of this guideline. If necessary, additional test samples are necessary.

6.11.2 *Visor*

The visor must be conditioned attached to the helmet in accordance with No. 6.3 and then tested for bullet resistance in accordance with No. 4.1. The helmet must be attached in accordance with Appendix 2.

6.11.3 *Neck guard*

The neck guard must be conditioned attached to the helmet in accordance with No. 6.3 and then tested for bullet resistance in accordance with No. 4.1. The attachment of the helmet must be performed in accordance with Appendix 2.

6.12 Ascertainment of the test results

For the test

- in accordance with Nos. 4.1, 4.2 and 4.3, an evaluation of the test must be conducted after every shot (see No. 3.3.5 of VPAM - APR 2006).

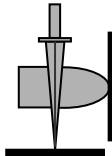
 <p>VPAM Vereinigung der Prüfstellen für angriffs- hemmende Materialien und Konstruktionen</p>	<p>Protective equipment Bullet-resistant helmet, visor and neck guard - Requirements, classifications and test procedures -</p>	<p>VPAM HVN 2009 Status: 04.04.2017</p>
--	---	---

- with regard to bulging/deformation, it must be ascertained in accordance with No. 4.2 whether that of the visor is not greater than 30 mm and a shot striking the neck guard was deflected laterally or downwards.
- the energy transferred to the head must be ascertained in accordance with No. 4.3.

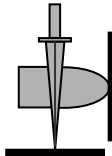
 <p>VPAM Vereinigung der Prüfstellen für angriffs- hemmende Materialien und Konstruktionen</p>	<p>Protective equipment Bullet-resistant helmet, visor and neck guard - Requirements, classifications and test procedures -</p>	<p>VPAM HVN 2009 Status: 04.04.2017</p>
--	---	---

7 Evaluation and documentation of the test, test certificate

The test must be evaluated and documented in accordance with VPAM - APR 2006, No. 7.

A test in accordance with this guideline is considered successful if

- in accordance with Nos. 4.1, 4.2 and 4.3 no shot is present in accordance with No. 3.3.5 of VPAM - APR 2006.
- No fragmentation was ascertained upon examination of the visor (foil not perforated).
- The bulging/deformation of the visor ascertained in accordance with No. 4.2 is not greater than 30 mm and no shot has escaped laterally or downwards when the neck guard is examined.
- The energy transmitted to the head in accordance with No. 4.3 does not exceed 25 joules.

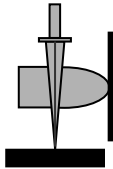

VPAM

Vereinigung der
Prüfstellen für angriffs-
hemmende Materialien
und Konstruktionen

Protective equipment
Bullet-resistant helmet, visor and neck guard
- Requirements, classifications and test
procedures -

VPAM
HVN 2009
Status: 04.04.2017

Appendix 1: Measuring and target construction (diagrammatic)

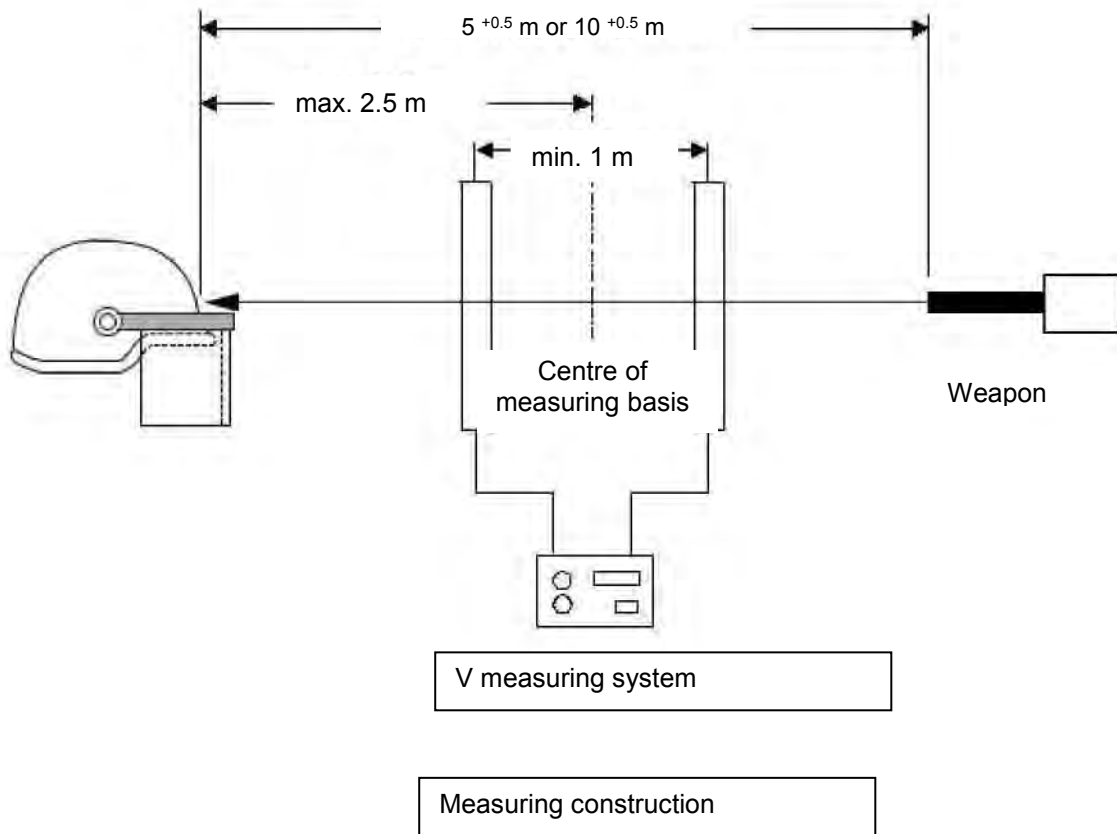

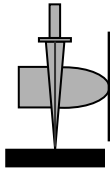

VPAM

Vereinigung der
Prüfstellen für angriffs-
hemmende Materialien
und Konstruktionen

Protective equipment
Bullet-resistant helmet, visor and neck guard
- Requirements, classifications and test
procedures -

VPAM
HVN 2009
Status: 04.04.2017

Appendix 2: Helmet attachment (diagrammatic)

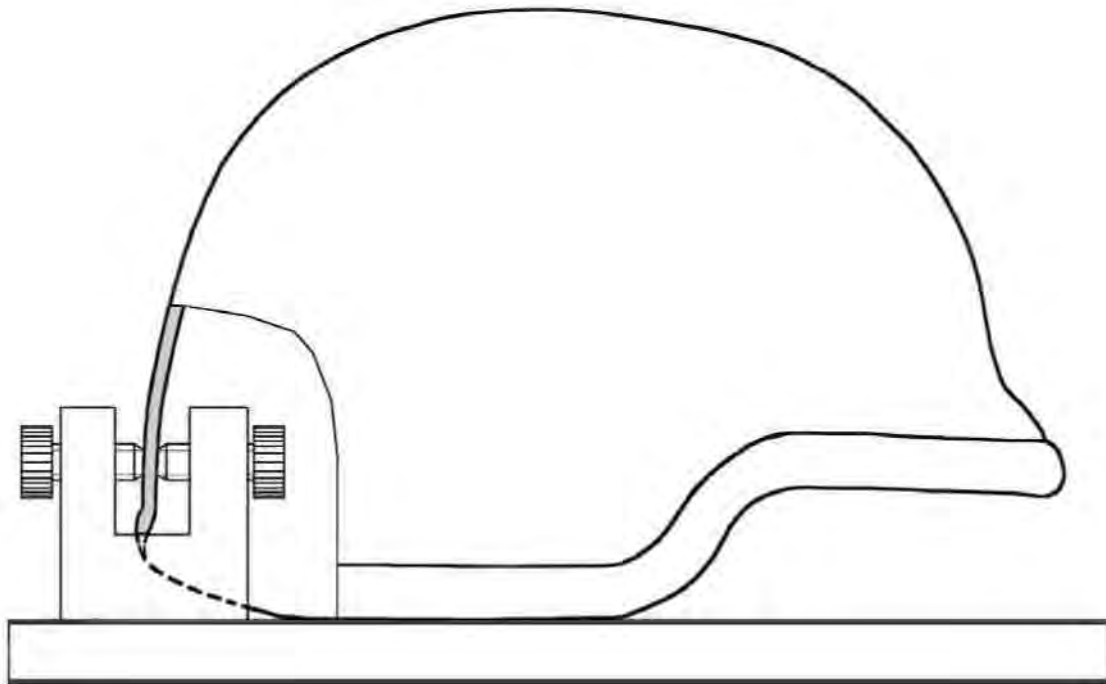

Helmet attachment, left and right (lateral) identical

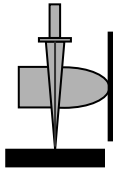

VPAM

Vereinigung der
Prüfstellen für angriffs-
hemmende Materialien
und Konstruktionen

Protective equipment
Bullet-resistant helmet, visor and neck guard
- Requirements, classifications and test
procedures -

VPAM
HVN 2009
Status: 04.04.2017

Appendix 3: Attachment of the bulging/deformation indicator for testing of the visor (diagrammatic)

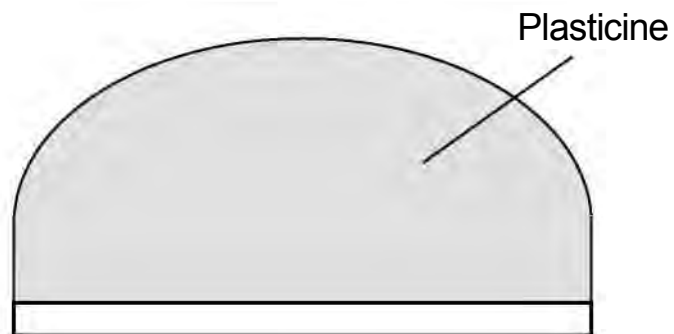
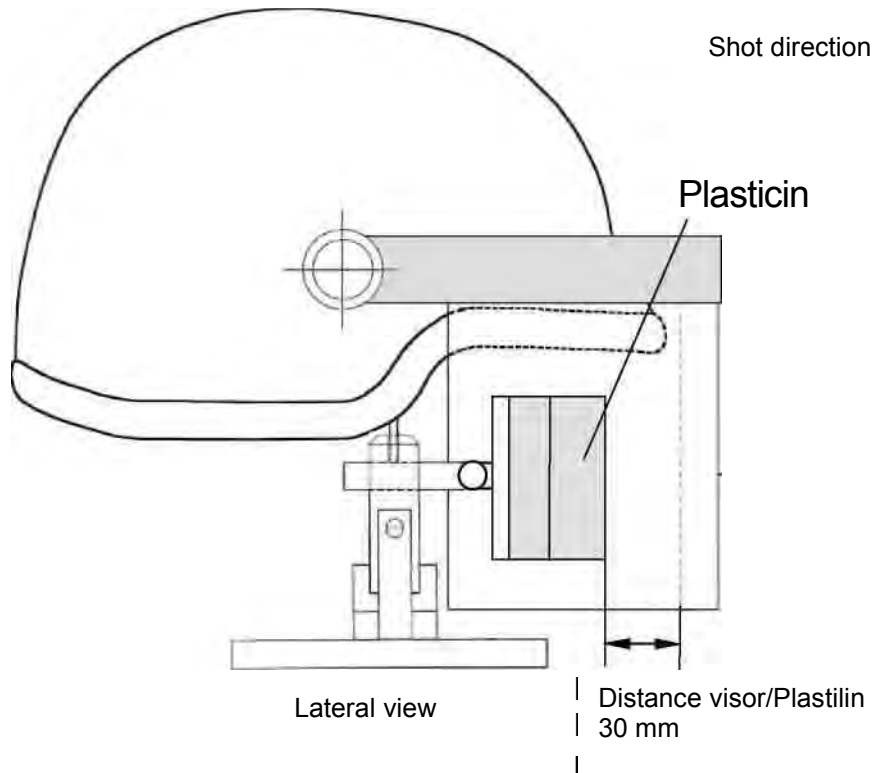

Top view of bulging/deformation indicator

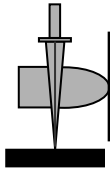

VPAM

Vereinigung der
Prüfstellen für angriffs-
hemmende Materialien
und Konstruktionen

Protective equipment
Bullet-resistant helmet, visor and neck guard
- Requirements, classifications and test
procedures -

VPAM
HVN 2009
Status: 04.04.2017

Appendix 4: Attachment of the bullet/splintering indicator (diagrammatic)

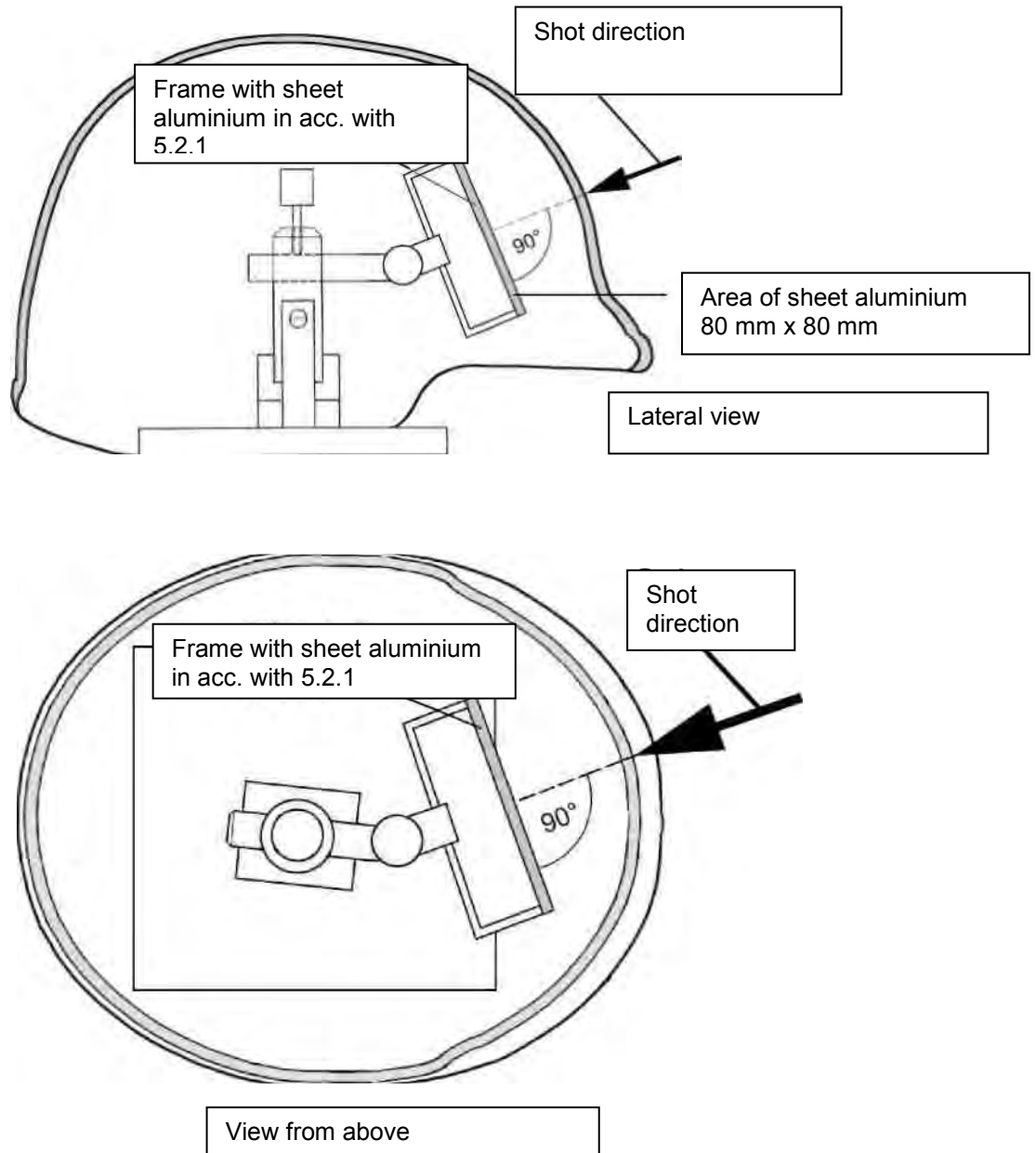

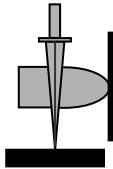

VPAM

Vereinigung der
Prüfstellen für angriffs-
hemmende Materialien
und Konstruktionen

Protective equipment
Bullet-resistant helmet, visor and neck guard
- Requirements, classifications and test
procedures -

VPAM
HVN 2009
Status: 04.04.2017

Appendix 4 (continued)

**Attachment of bullet/splinter indicator in the event of impact of the visor
(diagrammatic) or the bulge indicator**

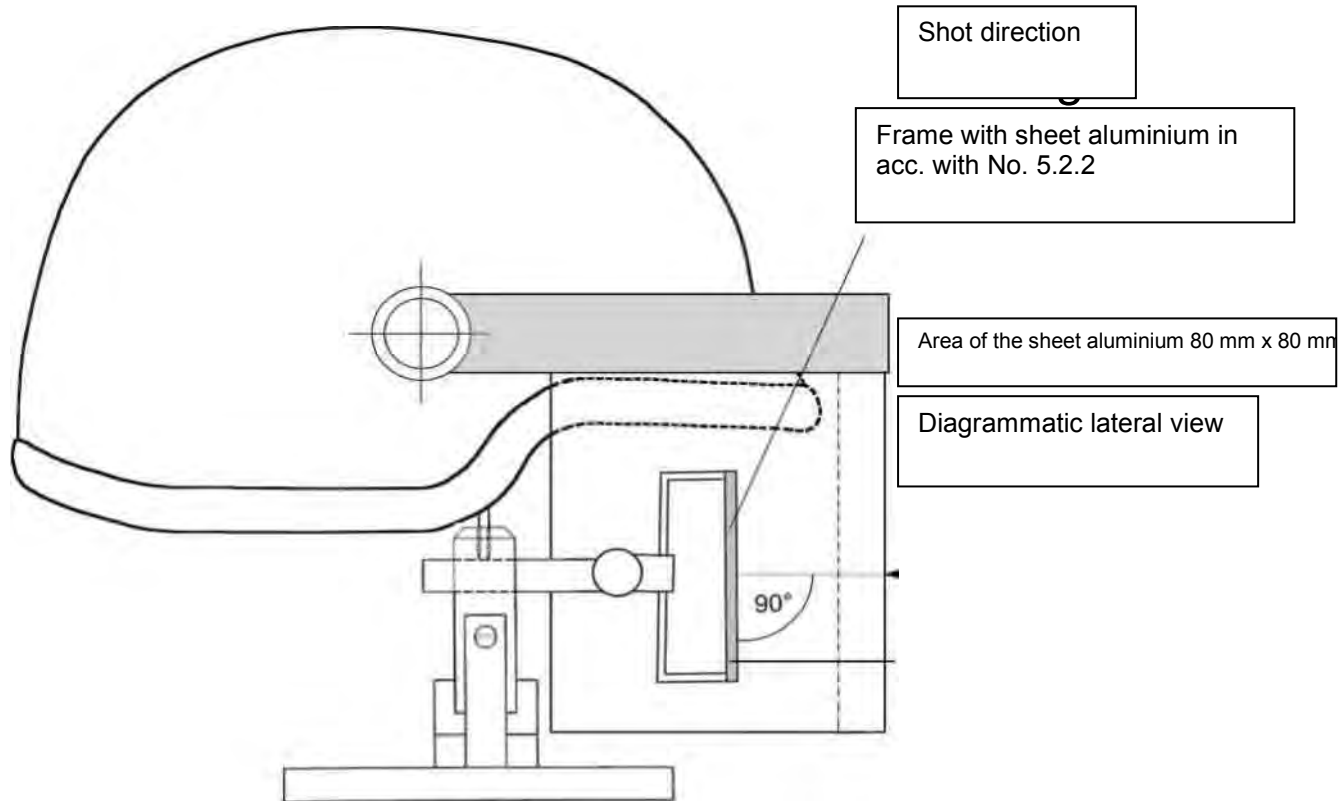

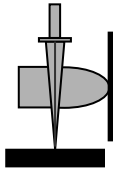

VPAM

Vereinigung der
Prüfstellen für angriffs-
hemmende Materialien
und Konstruktionen

Protective equipment
Bullet-resistant helmet, visor and neck guard
- Requirements, classifications and test
procedures -

VPAM
HVN 2009
Status: 04.04.2017

Appendix 5: Determination of the impact points on the visor (diagrammatic)

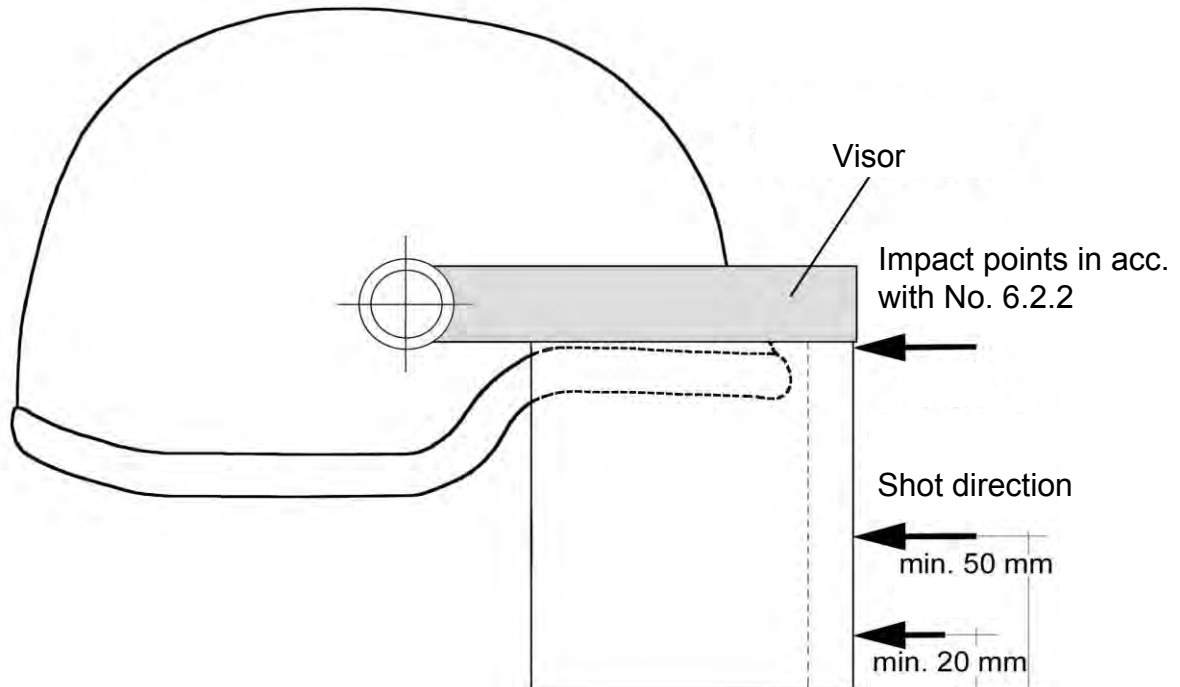

Lateral view

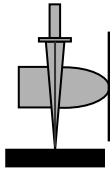

VPAM

Vereinigung der
Prüfstellen für angriffs-
hemmende Materialien
und Konstruktionen

Protective equipment
Bullet-resistant helmet, visor and neck guard
- Requirements, classifications and test
procedures -

VPAM
HVN 2009
Status: 04.04.2017

Appendix 6: Determination of the impact points on the helmet (diagrammatic)

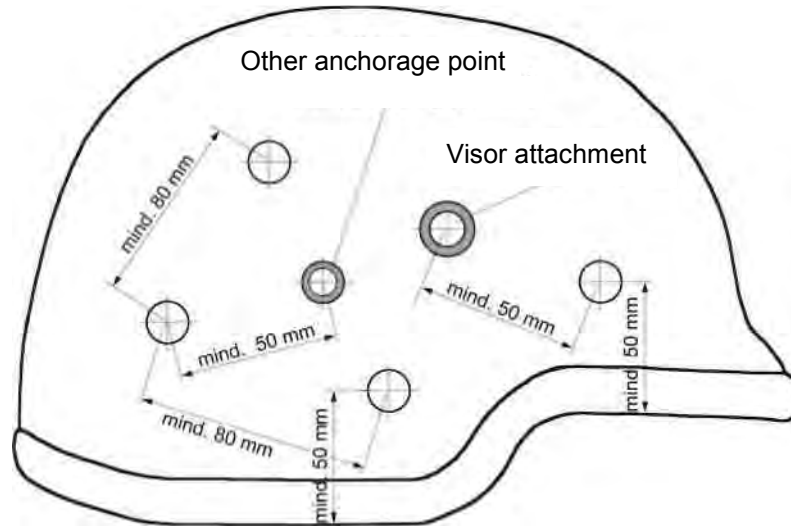

Lateral view

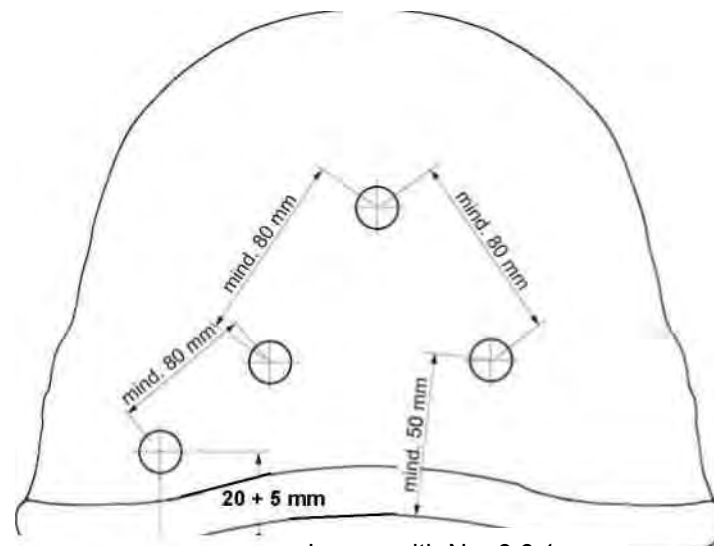

In acc. with No. 6.6.1

Rear view

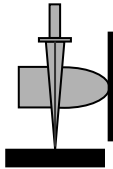

VPAM

Vereinigung der
Prüfstellen für angriffs-
hemmende Materialien
und Konstruktionen

Protective equipment
Bullet-resistant helmet, visor and neck guard
- Requirements, classifications and test
procedures -

VPAM
HVN 2009
Status: 04.04.2017

Appendix 7: Determination of the impact points on the neck guard (diagrammatic)

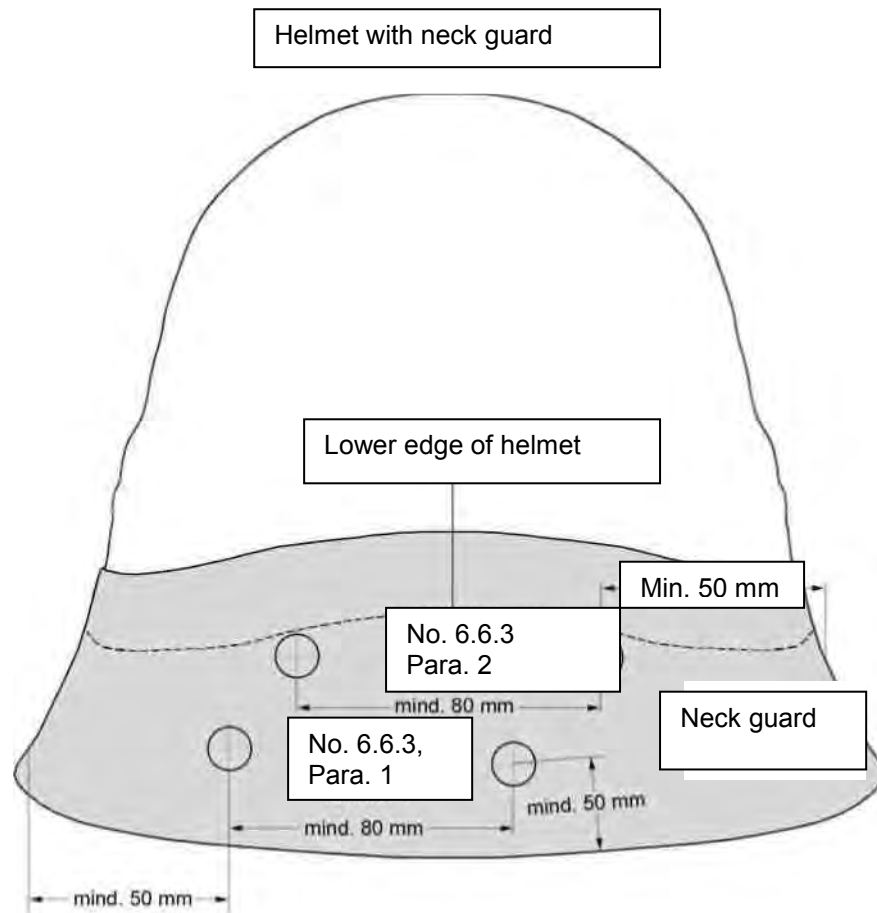

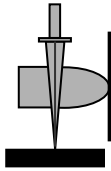

VPAM

Vereinigung der
Prüfstellen für angriffs-
hemmende Materialien
und Konstruktionen

Protective equipment
Bullet-resistant helmet, visor and neck guard
- Requirements, classifications and test
procedures -

VPAM
HVN 2009
Status: 04.04.2017

Appendix 8: Impact angle in acc. with No. 6.7

**(diagrammatic) applies analogously to visors
and neck guards**

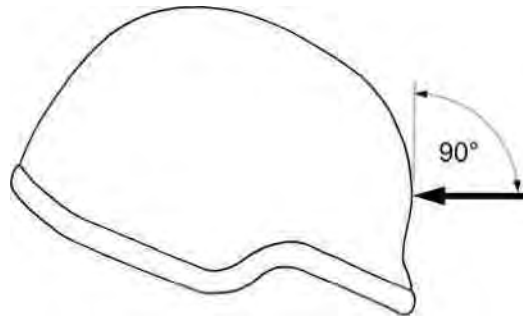

Lateral view

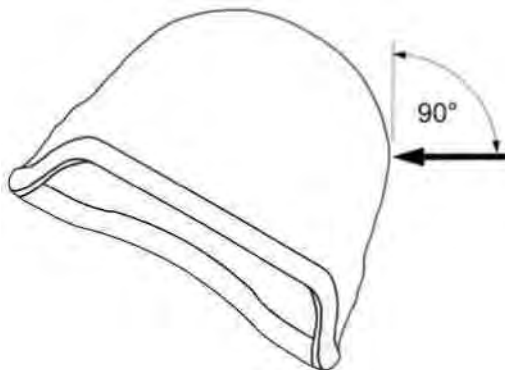

Front view

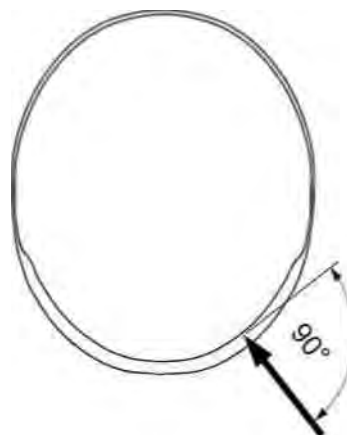

Top view

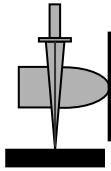

VPAM

Vereinigung der
Prüfstellen für angriffs-
hemmende Materialien
und Konstruktionen

Protective equipment
Bullet-resistant helmet, visor and neck guard
- Requirements, classifications and test
procedures -

VPAM
HVN 2009
Status: 04.04.2017

Appendix 9: Measuring head for ascertainment of the residual energy

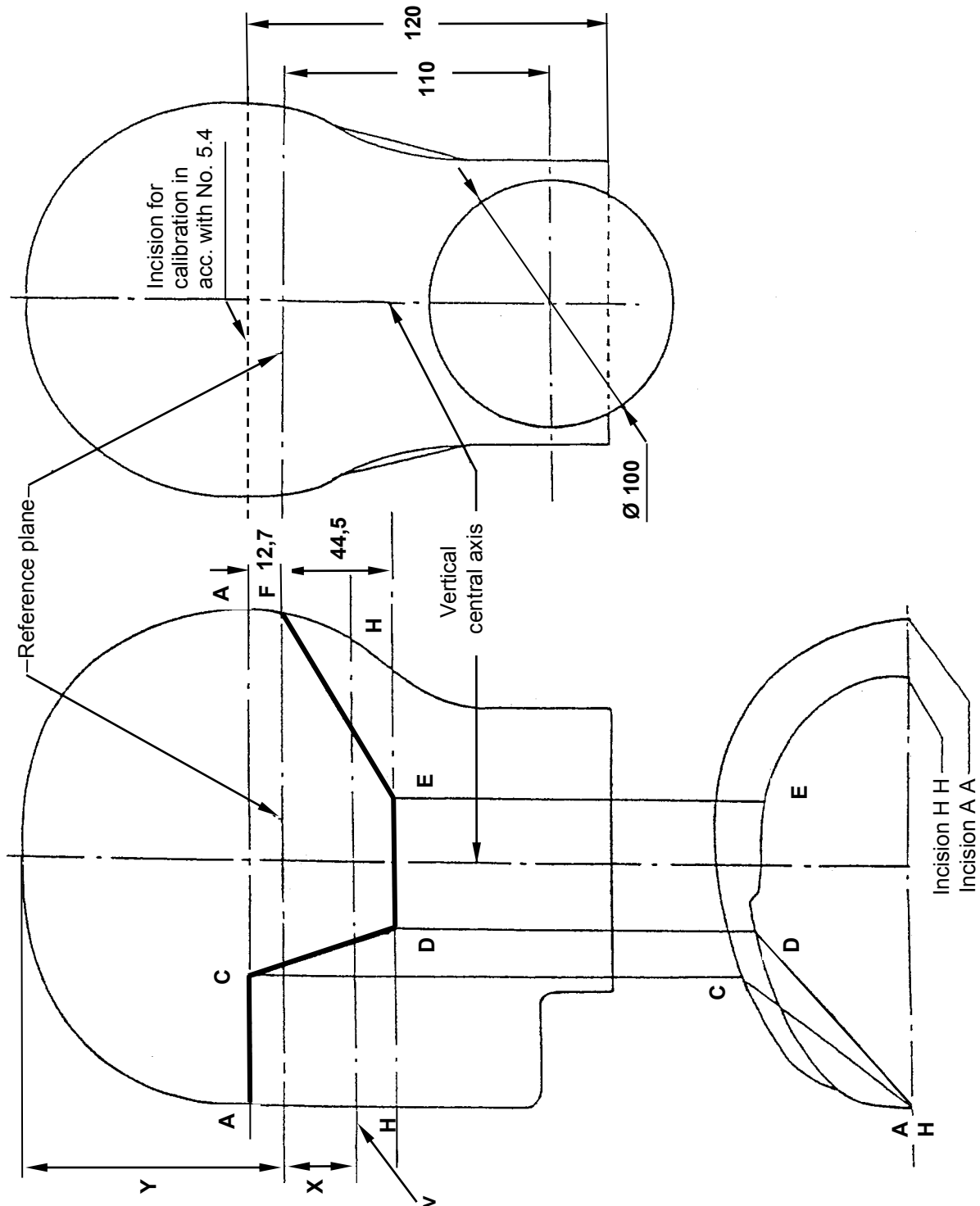

	<p style="text-align: center;">Protective equipment Bullet-resistant helmet, visor and neck guard - Requirements, classifications and test procedures -</p>	<p style="text-align: center;">VPAM HVN 2009 Status: 04.04.2017</p>
---	---	---

Appendix 9 continued

The measuring head for ascertainment of the residual energy must consist of ballistic soap. It must conform in shape and dimensions to a size 62 testing head which is described in Appendix 4 of ECE-R 22.